



Advanced Card Systems Ltd.
Card & Reader Technologies



ACR38 Series

PC-Linked Readers

A Product Presentation



Rundown



1. Product Overview
2. Product Feature
3. Product Value
4. Product Application
5. Q & A



Product Overview

Product Overview

The ACR38 Series is a family of Contact Smart Card Readers sharing the same core.



Product Overview



The ACR38 is the flagship product of ACS. It is a powerful and reliable smart card reader that supports smart cards conforming to ISO 7816.

The ACR38 default casing is the *Spaceship* Casing



Product Overview



ACR38UBMC

The ACR38 also comes in a bridge casing for vertical insertion of smart cards



Product Overview



ACR38K

Combine the functionality of a smart card reader and a PC keyboard for easy integration in a PC environment



Product Overview



ACR38F

The ACR38F is the ideal solution for easy integration of a smart card reader into the desktop environment.



Product Overview



ACR38T *Icebar* Casing

The ACR38T is a SIM-Sized
Smart Card Reader.



Product Overview



ACR38DT

The ACR38DT serves as a contactless card where in the embedded antenna coil inside the device enables the contactless part of the SIM-sized combi card to communicate with contactless readers.

Product Overview



ACR38ET DualKey2

Since the contact card's information is stored in the SIM card, while the contactless card information is stored in the ACR38ET itself, you can have a highly secure system based on data storage segregation.



Product Features

Product Features

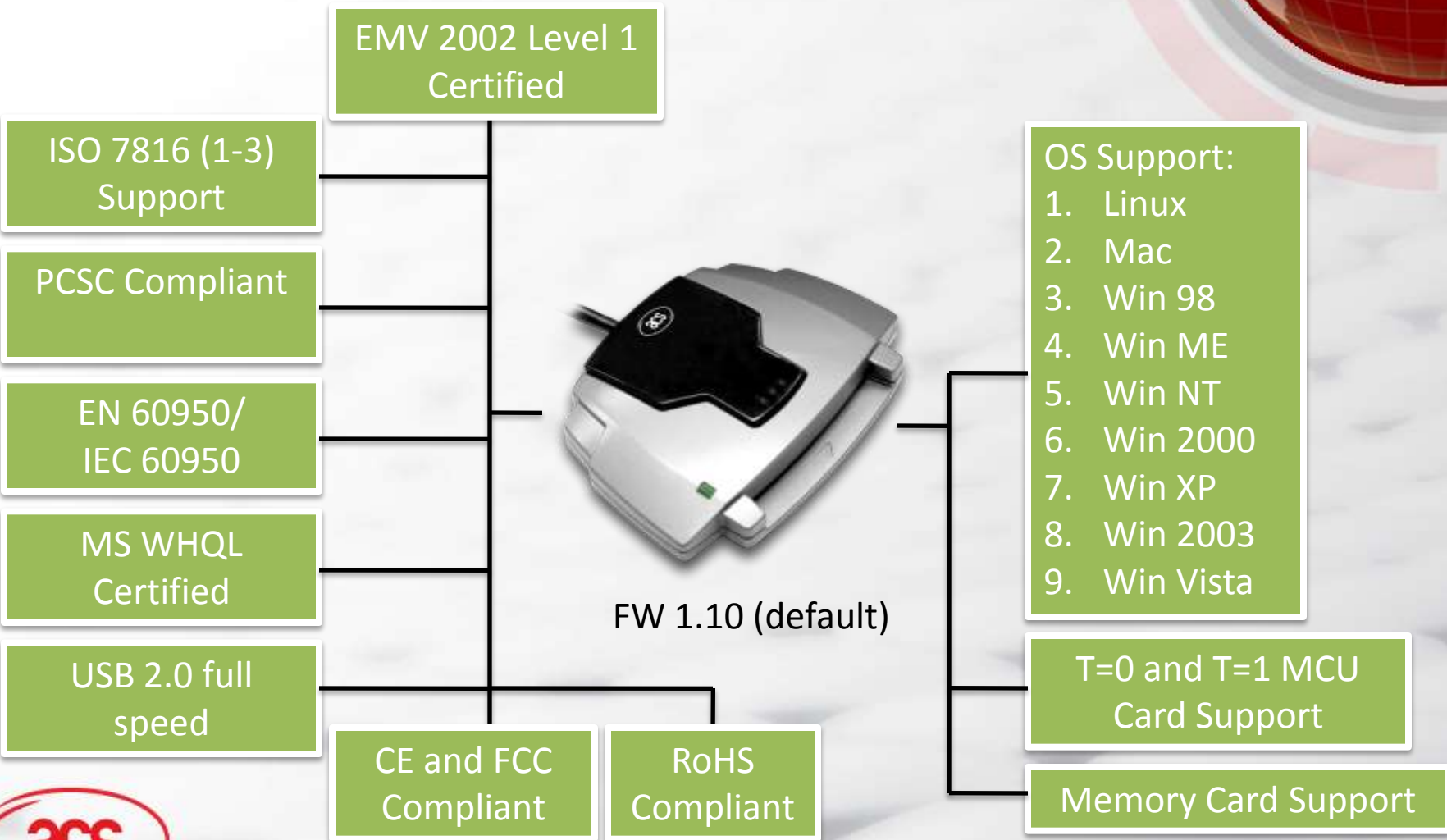

Product Features

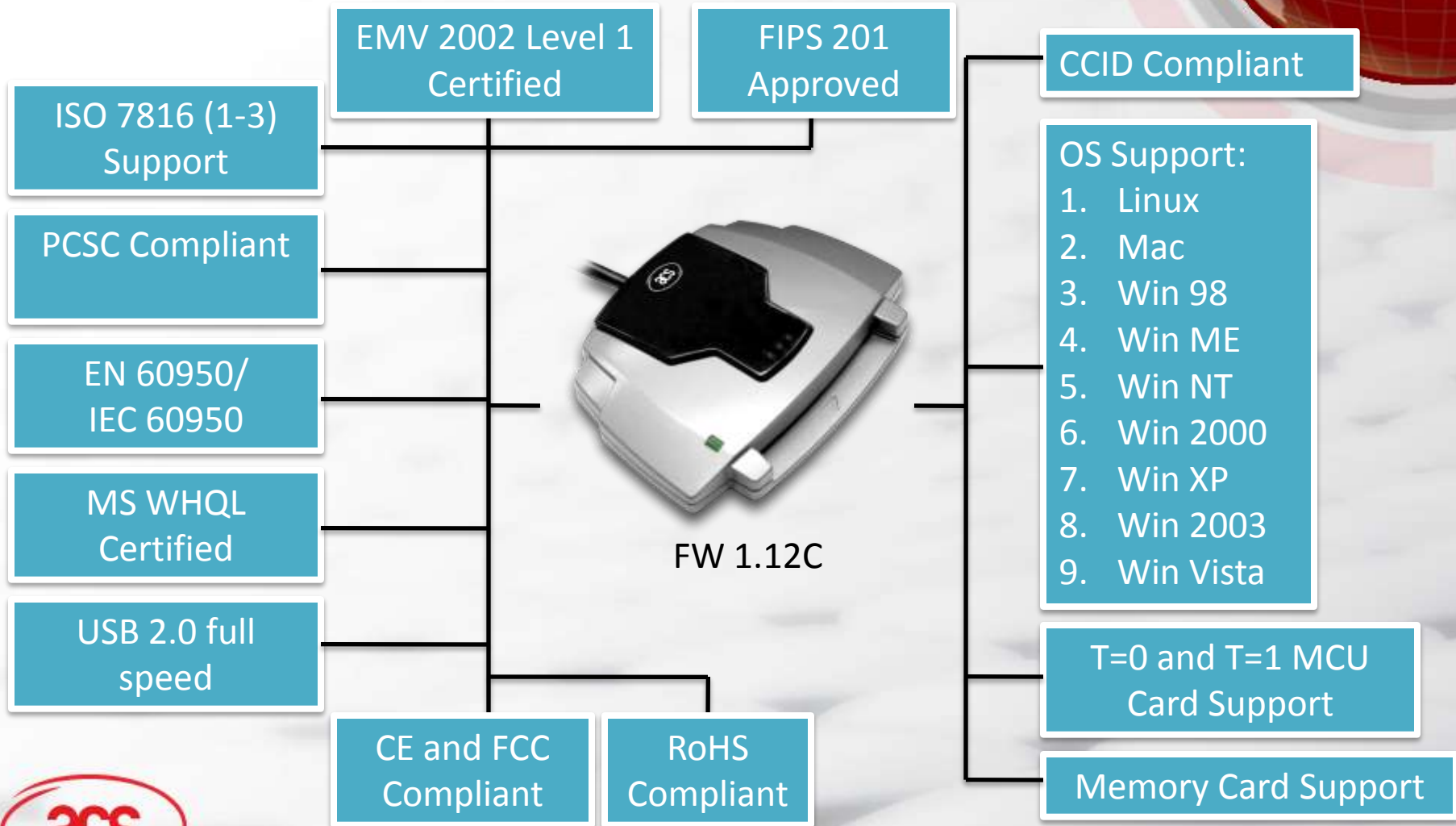

Product Features

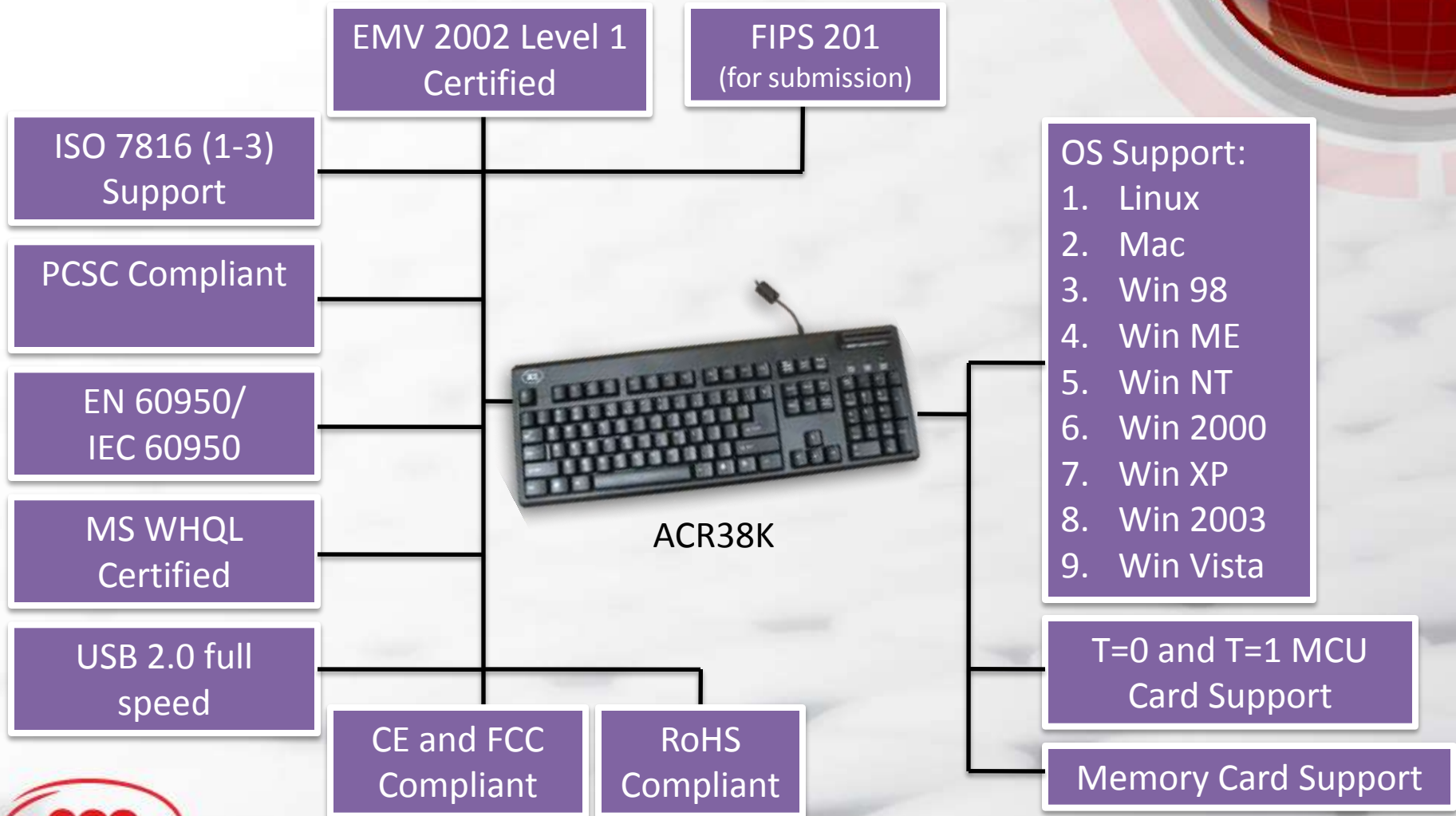

Product Features

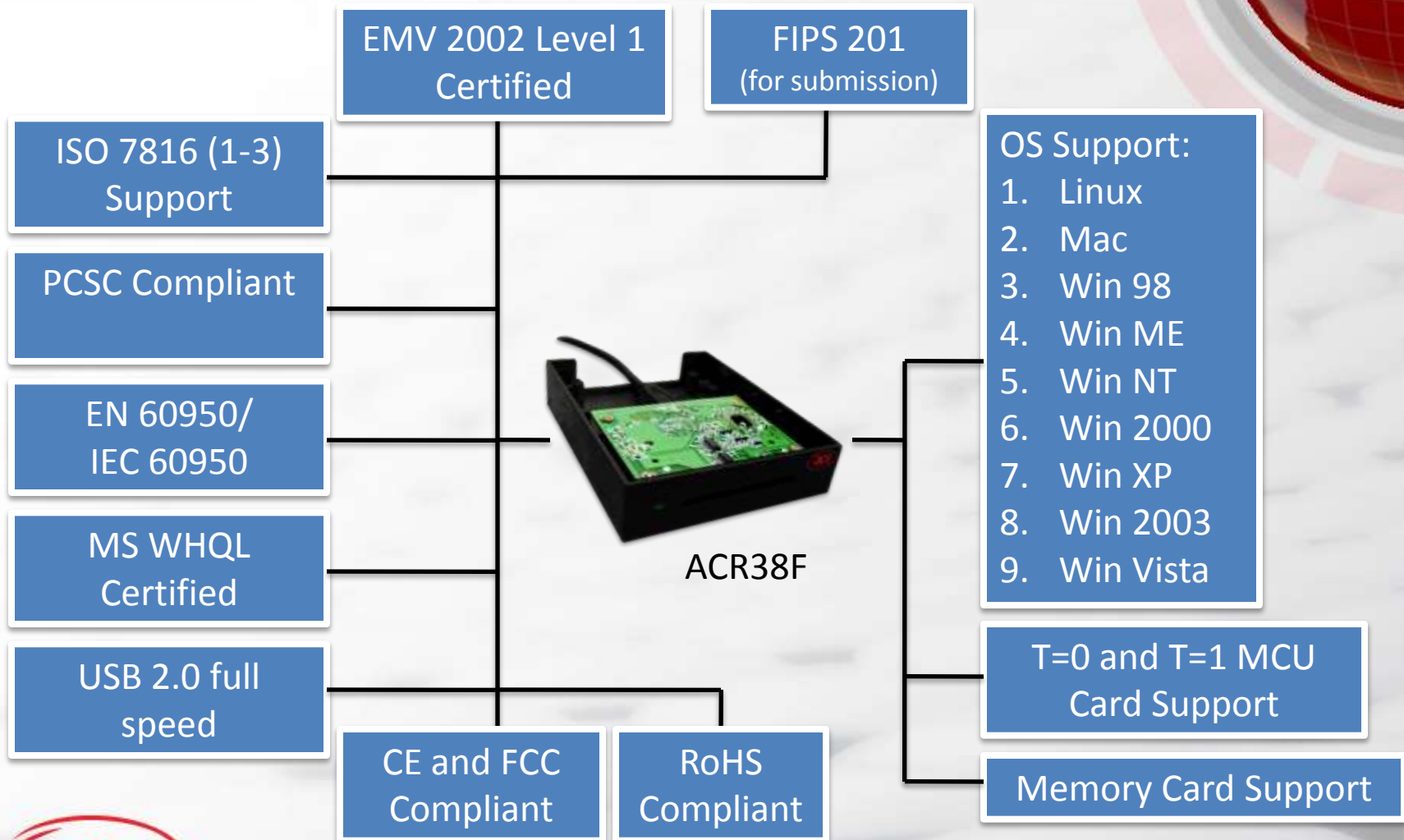

Product Features

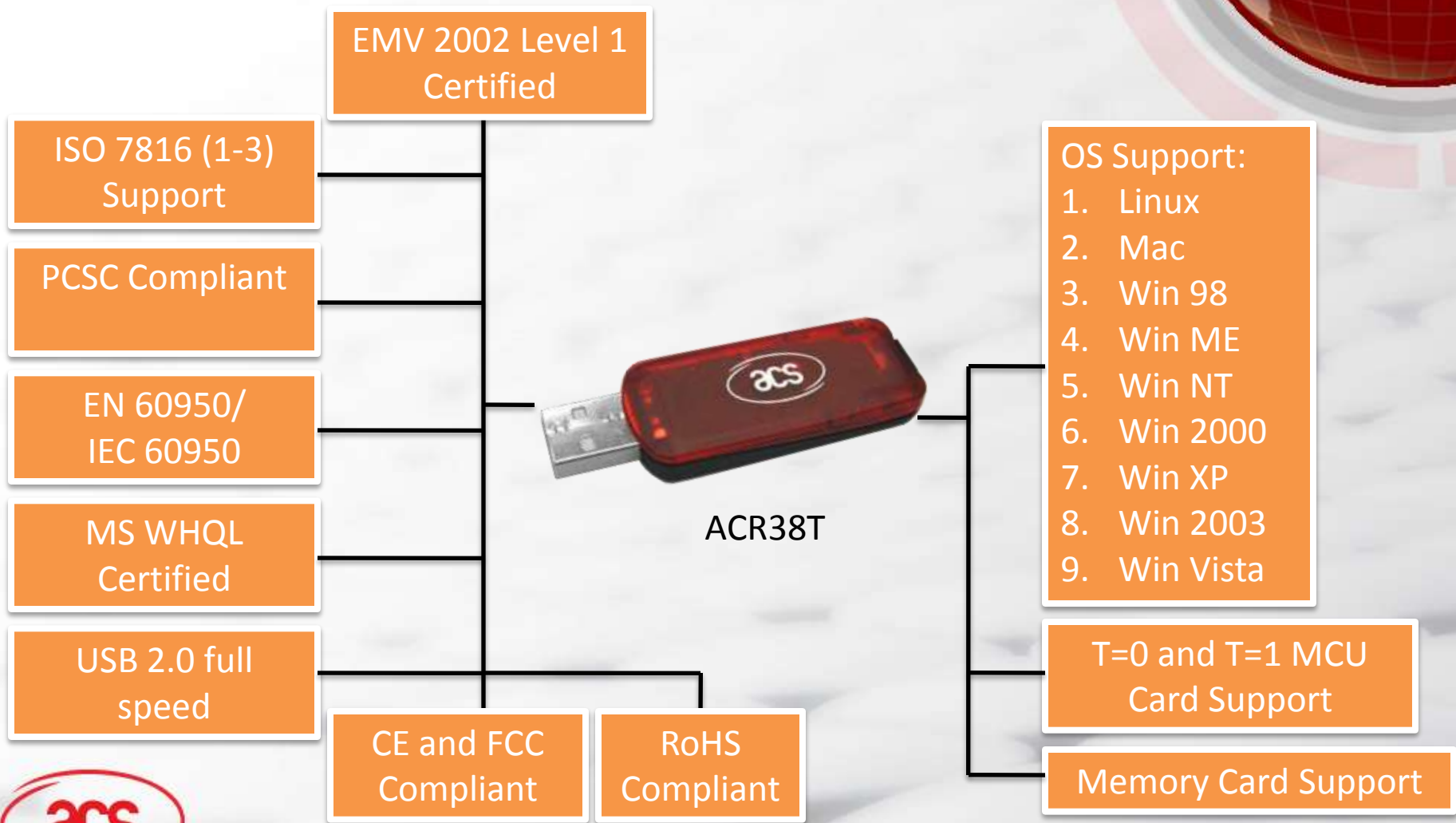

Product Features

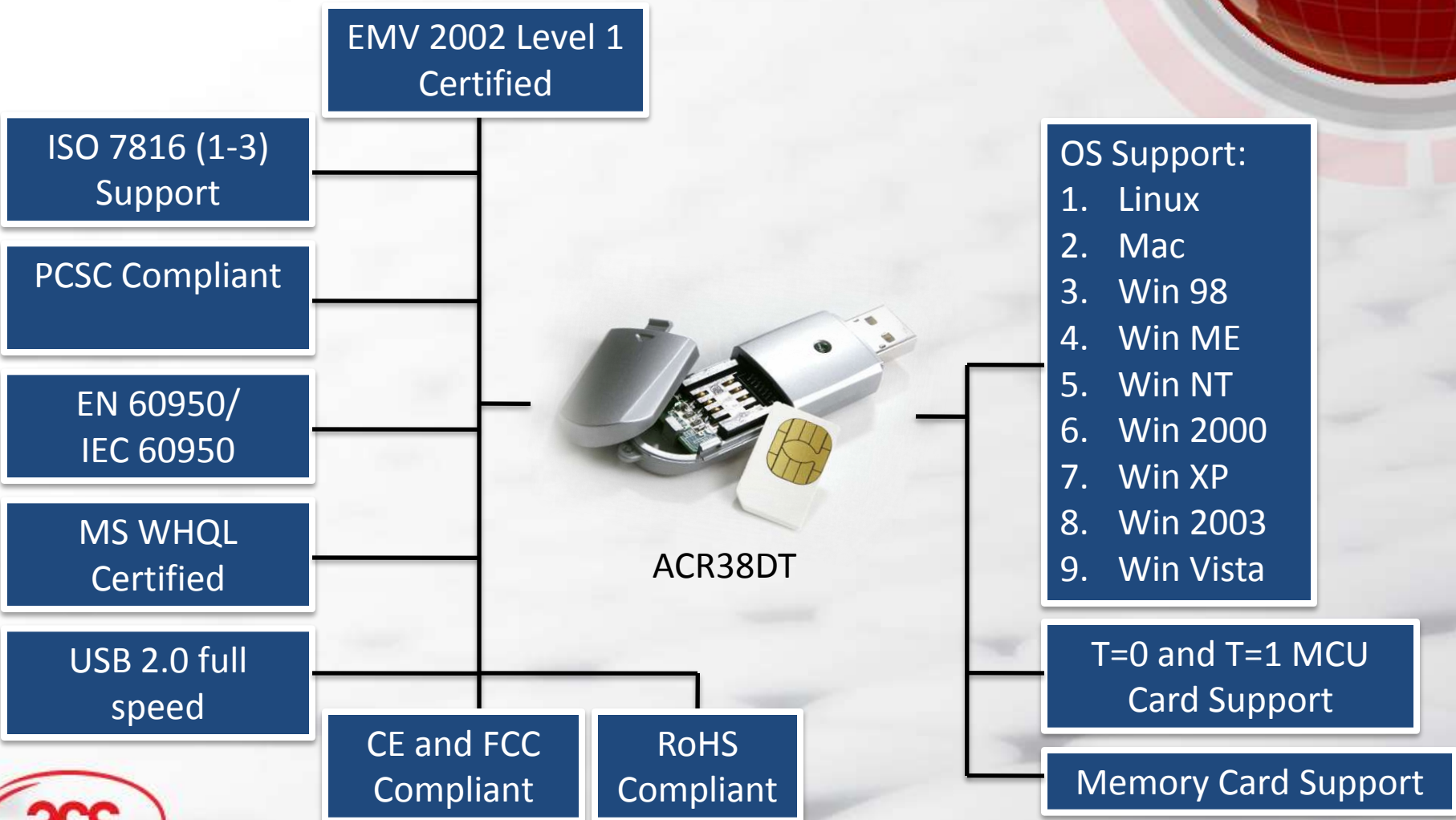

Product Features

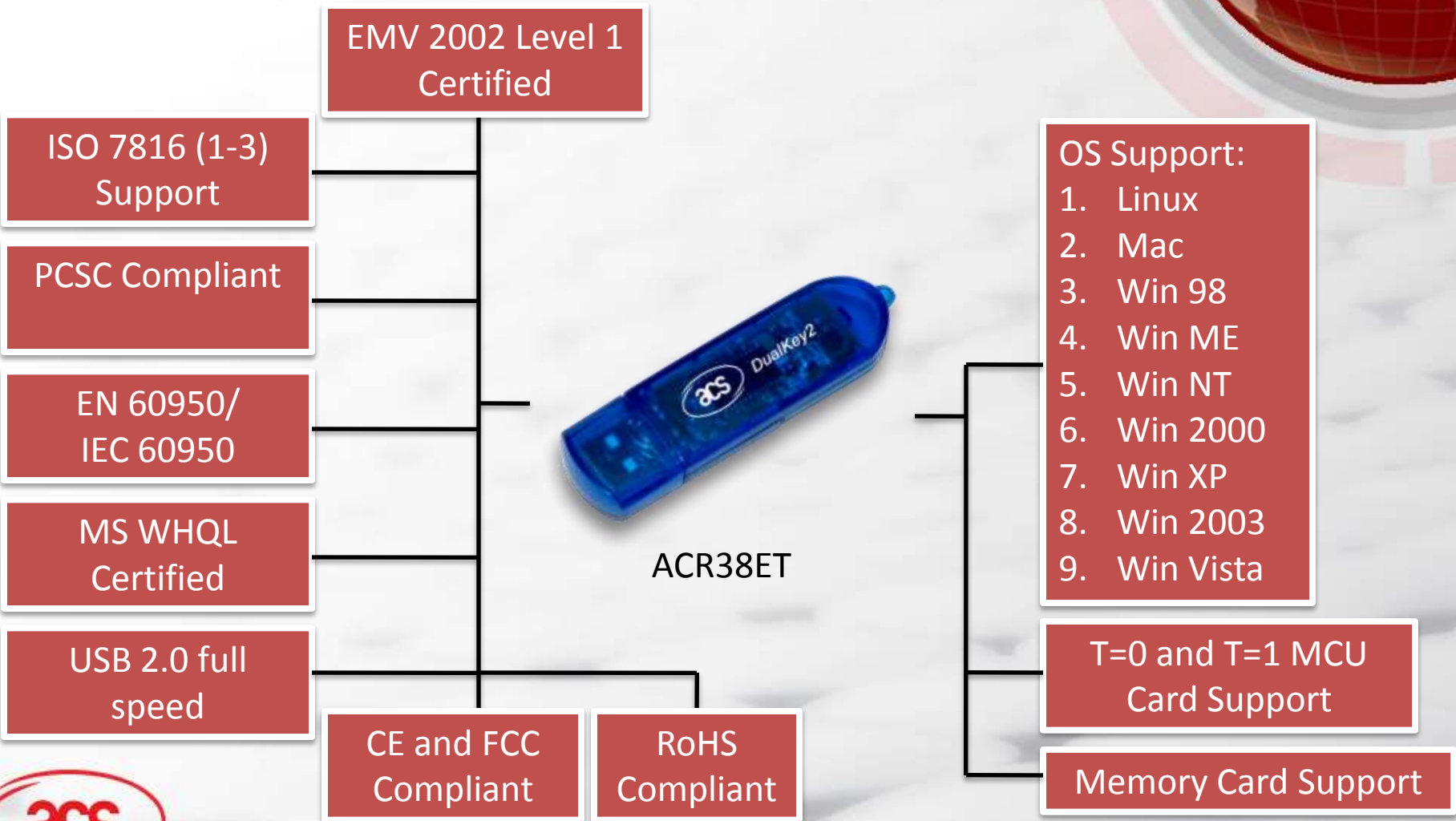



Product Value

Product Benefits

Cost-Effective

A powerful and durable which is also price competitive

Reliable

Widely used and well tested for different applications

Flexible

SAM Interface (Upon Request for ACR38)

Other form factors/casing designs

Can be customized to use Landing Connector instead of Sliding

High-speed I/O Operations

Can support Smart Card R/W Speed of 1743 - 250,000bps

Uses 12Mbps USB Speed



Product Application

In what areas can we apply ACR38?



Network Access Control



Digital Signature



Online Gaming



Payment system / e-Purse

PIV Applications

PKI Applications



eCommerce



Home Banking



GSM Management



Loyalty/Promotions



ACR38 Sample Application



Government issues smart ID cards to citizens



Smart Card Readers are sold or awarded to citizens who participate in the program



Government Services

Depending on the program, participants may benefit from applications such as digital signature, e-Commerce, parking, home banking, library card, etc.



Thank You!!!

More information on:

<http://acs.com.hk/pc-linked-smart-card-readers.php>

